

# Dehu<sup>®</sup>

PRODUCTS MANUFACTURING COMPANY

## Flow Line Products



### SUPPLIER OF ...

- OCTG and Accessories
- Well Head Products
- Flow Line Products



## Dehu Industries Private Limited



Call Number:  
**+91 90110 67039**



Mail Id  
**sales@dehuind.com**

[www.dehuind.com](http://www.dehuind.com)

## About Us



Dehu Industries is a multi-engineered product manufacturing company located in Chakan MIDC Pune. We are the premier supplier of performance on critical parts to global oil & gas industry. High precision complex machining and fabrication with complete supply chain management is our expertise.



All Dehu Ring Type Joints are manufactured from fully traceable materials and are supplied to NACE specifications upon request. Each Ring Type Joint is identified by low stress stamping with style, ring number, API license number, material reference, Product Specification Level (PSL), a unique Dehu material identification number, and month and year of manufacture. Such full and comprehensive traceability, from material source with mill certification to final supply, is an essential ingredient in the company's strict quality assurance procedures and compliances API 6A requirements.

MATERIAL	UNS NUMBER	MAXIMUM HARDNESS		IDENTIFICATION
		BRINELL (BHN)	ROCKWELL (HRB)	
Soft Iron	--	90	56	D
Low Carbon Steel	--	120	68	S
4-6% Chrome 1/2% Moly (F5)	K42544	130	75	F5
SS304	S30400	160	82	304
SS316	S31600	160	82	316
SS321	S32100	160	82	321
SS347	S34700	160	82	347
SS410	S41000	160	82	410
Alloy 600	N06600	200	92	N06600
Alloy 625	N06625	200	92	N06625
Alloy 800	N08800	200	92	N08800
Alloy 825	N08825	160	82	N08825
Alloy C276	N10276	200	92	N10276
SMO 254	S31254	180	89	S31254
Duplex	S31803	250	99	S31803
Super Duplex	S32760	200	92	S32760
Monel 400	N04400	135	75	N04400
Titanium Gr. 2	R50400	200	92	R50400

## R Type



The R Type Ring Joint Gasket fits the round and flat bottom ring groove flange. Available in both oval or octagonal, both types are interchangeable on modern octagonal type grooved flanges.

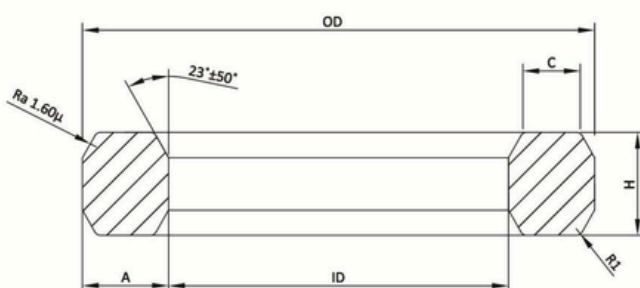

R - Octagonal Gasket Style

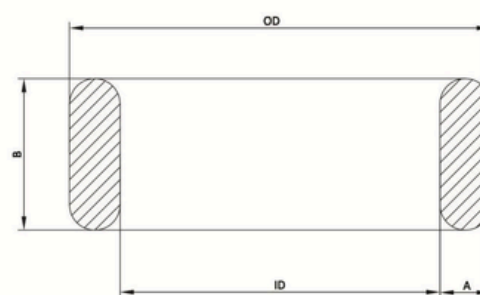

R - Oval Gasket Style

Dimension Tolerances Inches (mm)		
	API 6A	ASME B16.20
A - Width of ring	± 0.008 (0.20)	± 0.008 (0.20)
B, H - Height of ring	± 0.02 (0.50)	± 0.051 /- 0.019 (+ 1.3/-0.50)
C - Width of flat	± 0.008 (0.20)	± 0.008 (0.20)
OD - Outer Diameter of ring	± 0.007 (0.18)	± 0.007 (0.18)
ID - Inner Diameter of ring	± 0.007 (0.18)	± 0.007 (0.18)
R1 - Radius	± 0.002 (0.50)	± 0.02 (0.50)
23° Angle of sealing face	± 0.50°	± 0.50°

## BX Type



These basic shapes of the Ring Joint Gaskets are used in a variety of applications with pressures up to 20,000 PSI. The dimensions are standardized and they require specially grooved flanges on which a corresponding "R" or "BX" number is assigned for pipe size and pressure class for gasket identification. All BX sizes have a pressure relief hole to equalize pressure across sealing faces.

**BX Type  
Ring Gasket**

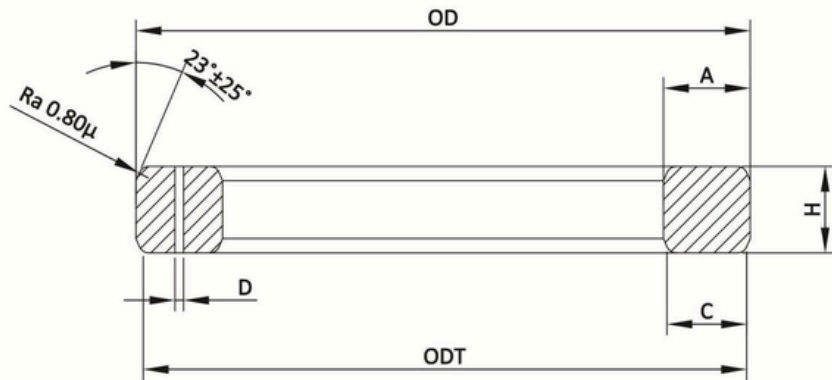

Dimension Tolerances Inches (mm)		
	API 6A	ASME B16.20
A - Width of ring	+ 0.008/-0.00 (+ 0.20/-0.00)	+ 0.008/-0.00 (+ 0.20/-0.00)
H - Height of ring	+ 0.008/-0.00 (+ 0.20/-0.00)	+ 0.008/-0.00 (+ 0.20/-0.00)
C - Width of flat	+ 0.006/-0.00(+ 0.15/-0.00)	+ 0.006/-0.00(+ 0.15/-0.00)
OD - Outer Diameter of ring	+ 0.00/-0.006 (+ 0.00/-0.15)	+ 0.00/-0.006 (+ 0.00/-0.15)
ODT - Outside diameter of flat	± 0.002 (0.05)	± 0.002 (0.05)
D - Hole Size	± 0.02 (0.50)	± 0.02 (0.50)
23° Angle of sealing face	± 0.25°	± 0.25°

## RX Type



The RX has an increased height and utilizes the internal system pressure to energize and improves the seal as internal pressure increases. Some RX sizes have a pressure relief hole to equalize pressure on both sides of the sealing faces.

RX Type Ring Gasket

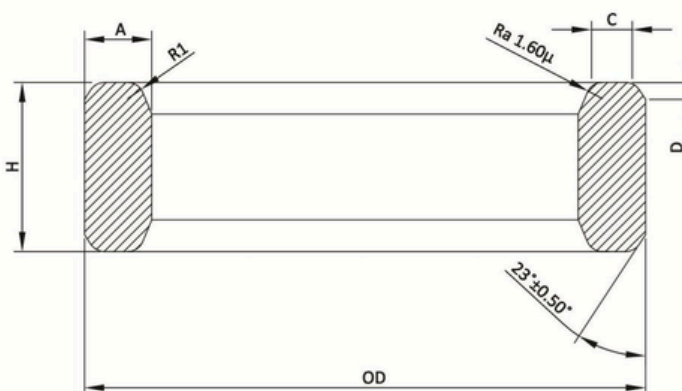

Dimension Tolerances Inches (mm)		
	API 6A	ASME B16.20
A - Width of ring	+ 0.008/-0.00(+0.20/-0.00)	+ 0.008/-0.00(+0.20/-0.00)
H - Height of ring	+ 0.008/-0.00(+0.20/-0.00)	+ 0.008/-0.00(+0.20/-0.00)
C - Width of flat	+ 0.006/-0.00(+ 0.15/-0.00)	+ 0.006/-0.00(+ 0.15/-0.00)
OD - Outer Diameter of ring	+ 0.02/-0.00(+0.50/-0.00)	+ 0.02/-0.00(+0.51/-0.00)
D - Height of outside bevel	+ 0.00/-0.032(+0.00/-0.80)	+ 0.00/-0.030(+0.00/-0.76)
R1 - Radius	± 0.02 (0.50)	± 0.02 (0.50)
23° Angle of sealing face	± 0.50°	± 0.50°

Dehu plug valves act as quarter-turn isolation valves, allowing operators to isolate portions of their flow line or specific pumping units from the entire pumping system in order to address pumping, operational or maintenance requirements. The valves require minimum space, are simple to operate, exhibit a fast response, and add relatively little internal disturbance to the flow. Pressure drop across the valve is low. Dehu plug valves are designed to reduce required operating torque to improve ease of use.

Dehu plug valves are available in sizes ranging from 1" to 3" in working pressures up to 15,000 psi. They feature precision machined and ground components, which aid in proper sealing at a wide range of operating pressures, and plating on critical areas for improved corrosion resistance.



- Standard service is used up to 15000 psi and tested at 22500 psi.
- Sour service(H<sub>2</sub>S) is used up to 10000 psi and tested at 15000 psi.
- Rugged construction with forged alloy steel body.
- Reliable performance at high pressure.
- Bottom entry design and easy maintenance.
- Valve parts are interchangeable with most major brands.
- Suitable for applications such as fracturing, cementing, acidizing and etc.
- Each valve is serialized.
- MTR and Test reports are available.
- Available in sizes 1" to 3" up to 15000 psi working pressure.

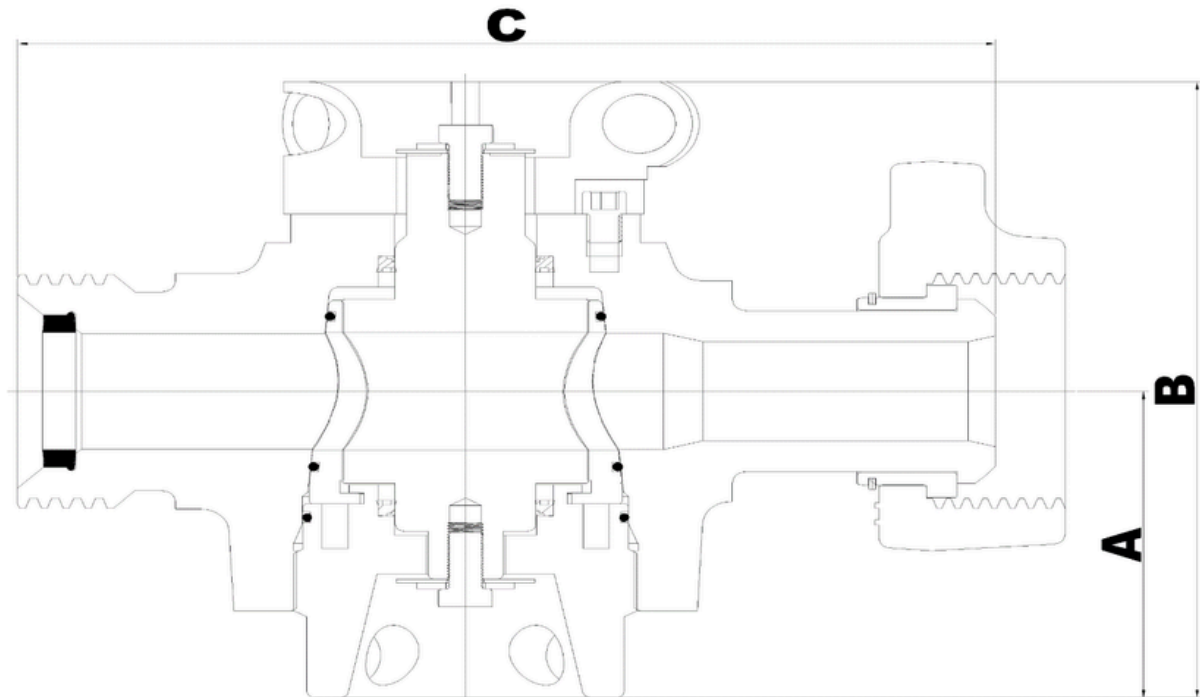

Size	End Connection Type	Service	Working Pressure (psi)	Test Pressure (psi)	DIMENSIONS (inches)			Weight in lb (kg)
					A	B	C	
2" x 1"	1502 M X F	STD	15000	22500	4.74	9.24	10.5 3	27.23 (60.0)
		SOUR	10000	15000				
2" x 2"	1502 M X F	STD	15000	22500	5.41	10.67	13.88	87.40 (39.67)
		SOUR	10000	15000				
3" x 3"	1502 M X F	STD	15000	22500	5.41	10.67	13.88	188 (85.26)
		SOUR	10000	15000				

## PLUG VALVE PART LIST

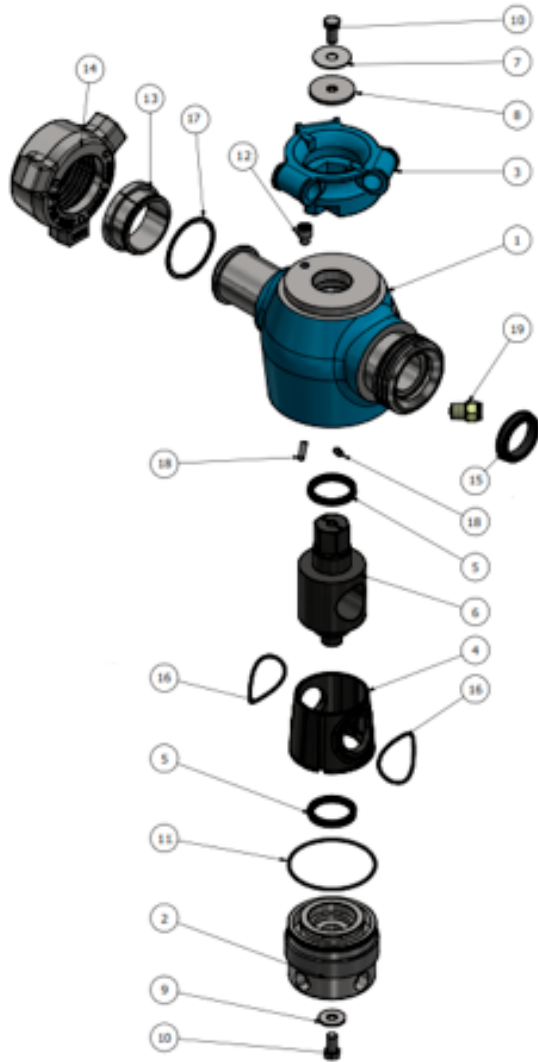

### REPAIR KIT DETAILS

**\* Marked Items are supplied as major repair kit for Plug Valves**

ITEM	QTY.	DESCRIPTION
1	1	Body
2	1	Bonnet
3	1	Handle Actuator
4*	1	Metal seat
5*	2	Plug Seal
6*	1	Plug
7	1	Washer
8	1	Washer
9	1	Washer
10	2	Hex Bolt
11*	1	O-ring
12	1	Allen Bolt
13	1	Segment Ring
14	1	Wing Nut
15	1	Packing Seal
16*	2	Metal seat O-ring
17	1	Segment Retaining ring
18	2	Metal seat Guide Pin
19	1	Grease Fitting



Hammer unions allow quick connecting the pipelines and flexible hose assemblies in the oil and gas industry . They are popularly used on onshore and offshore drilling rigs to transfer petroleum, gas, drilling mud, cement, water, air and many other media.

Dehu offers a comprehensive range of standard and sour gas Hammer Unions. Each union is thoroughly inspected to ensure long, dependable service in the most extreme conditions.

## SPECIFICATIONS

- Range size: 1/2"-12"
- ASTM A-105 for a working pressure less than 6,000psi
- AISI 4130 for a working pressure greater than or equal to 6,000psi
- Meet the National Association of Corrosion Engineers standard NACE MR-01-75
- Maximum cold working pressure: 15,000psi

### Material

Dehu Unions are manufactured from steel forgings using materials appropriate to specific pressure ratings.

### Sour Service

Dehu Unions are available in H2S service and comply with the latest NACE specifications.

### Interchangeability

All Dehu unions interchangeable with leading brands.

## FEATURES

- Complete traceability
- Three lug nuts and self-locking ACME threads provide quick make-up and break-out
- Color coded for quick identification
- All unions provide pressure-tight & positive sealing for low-pressure services (500 to 2,000 PSI)
- The spherical surface male sub and angular surface female sub-form a metal-to-metal seal, the ball and tangent provides a perfect seal
- Fully interchangeable with most major brands of Hammer Unions.

### End Connections

Dehu Unions offers products with various end connection options. API line pipe threads are standard, and butt weld ends are available upon request. Customers should specify the pipe schedule when placing their orders..

### Low Temperature Service

Dehu Unions can be supplied for low temperature applications with suitable impact value testing.

### Traceability

Dehu Unions supplied with full traceability documentation for each component.

Fig. No.	Assembly Colour Key for Standard Service	Pressure Rating (psi)				Nominal Pipe Size (in mm.)												
		Standard Service		Sour Gas Service		1"	1 <sup>1/4</sup>	1 <sup>1/2</sup>	2	2 <sup>1/2</sup>	3	4	5	6	8	10	12	
		Cold Working	Test	Cold Working	Test	25	32	40	50	65	80	100	125	150	200	250	300	
50		500	750	NA	NA									✓				
100		1,000	1,500	NA	NA				✓	✓	✓	✓	✓	✓	✓	✓		
200		2,000	3,000	NA	NA	✓	✓	✓	✓	✓	✓	✓	✓	✓	✓	✓		
206		2,000	3,000	NA	NA	✓	✓	✓	✓	✓	✓			✓	✓	✓		
207		2,000	3,000	NA	NA						✓	✓		✓				
211		2,000	3,000	NA	NA				✓		✓							
400		2,500	3,750	2,500	3,750									✓	✓	✓	✓	
400		4,000	6,000	4,000	6,000				✓		✓	✓						
600		6,000	9,000	NA	NA	✓			✓		✓	✓						
602		6,000	9,000	6,000	9,000	✓	✓	✓	✓		✓	✓						
1002		10,000	15,000	7,500	11,250	✓	✓	✓	✓		✓	✓	✓					
1003		10,000	15,000	7,500	11,250				✓		✓	✓	✓					
1502		15,000	22,500	10,000	15,000	✓			✓		✓	✓	✓					
2002		20,000	30,000	NA	NA				✓		✓	✓						
2202		NA	NA	15,000	22,500				✓		✓	✓						



## HOSE UNIONS



- Dehu Hose Unions are manufactured from steel Forgings using materials appropriate to specific pressure ratings up to 400 psi.
- Fig 206 ‘O ring for improved sealing, barb style connection with ss snap ring for safety.

## BLINDS AND TEST PLUGS



- Dehu offers Male and Female Blind with or without NPT ports.
- Available Size 1” to 12” with Fig 602 and Fig 1502.
- Available in Standard and Sour Service.
- Dehu also provides the test plugs as per the Customer’s required connections.



Swivel Joints are manufactured both for standard service & sour service. Long sweep swivel joints are designed generally from 6000 PSI CWP to 20,000 PSI CWP, both for standard and sour service and ensure better flow characteristics. Smooth and round bore design keeps pressure drop low and minimizes turbulence.

Long sweep sour service swivel joints are manufactured in accordance with NACE standard, MR-01 – 75 (Latest).

### Swivel Joints Code Red – Long Radius

- Dehu offers extra high-pressure long radius Swivel Joints, Figure 1502 & 1002, In 2”, 3” & 4 “ Sizes.
- Recommended for test line, fracturing, cementing & well servicing up to 15000 PSI CWP.
- Precision machined from forged alloy materials heat-treated for longer service.
- Three ball-bearing race bases that more evenly share moment loads.
- Optimal combination of core strength and case hardness, without sacrificing ductility.
- Available Styles No. 10 to Styles No. 100
- Available in both Standard and Sour Services.

### Quick Reference Chart

Models	Color-Coding	Cold Working Pressure (psi)	Material	End Connections	Sizes								Notes	
					3/4	1	1-1/4	1-1/2	2	2-1/2	3	4		
High-Pressure Swivel Joints BSR	Dark Blue	3,000	Carbon Steel	Threaded	•	•	•	•	•	•	•	•	•	1
	Silver	6,000		Threaded	•	•	•	•	•	•	•	•	•	•
Long Radius Swivel Joints	Olive Green*	10,000	Alloy Steel	Figure 1502 Union		Sour Gas		Sour Gas	Sour Gas		Sour Gas	Sour Gas		2
	Black	10,000	Alloy Steel	Female Line Pipe Threads					•					3
	Red*	15,000	Alloy Steel	Figure 1502 Union		•		•	•		•	•		1

## Swivel Joints Code Silver – Short Radius

- High-pressure swivel joints 6000 PSI CWP in 1", 2" & 3" with LPT.
- For test lines, fracturing, acidizing, & well servicing up to 6000 PSI.
- Swivel joints can be custom-configured in any style.
- Material traceability reports are included at no extra charge.



**Style 10**  
3 Swivels, 2 Elbows



**Style 20**  
1 Swivel



**Style 30**  
1 Swivel, 1 Elbow



**Style 40**  
1 Swivel, 2 Elbows



**Style 50**  
2 Swivels, 2 Elbows



**Style 60**  
2 Swivels, 1 Elbow



**Style 70**  
2 Swivels, 3 Elbows



**Style 80**  
3 Swivels, 3 Elbows

- Standard Swivel Joints are provided with API line pipe threads.
- Heavy duty hex head style ball loading plug.
- Available for standard service.



- Extra High-pressure Cementing / Circulating Hose Loops, Figure 1502,1002 & 602 in 2" & 3" sizes of length 10 foot and 12 foot.
- For test lines, fracturing, acidizing, cementing & well servicing up to 15000 & 6000 PSI CWP.
- Hose loops can be custom-ordered in non-standard lengths.
- Manufactured to the highest quality standards in the industry.
- Available in both Standard and Sour Service for Fig. 1502 & 1002 and Standard service for 602 (Silver Code).
- For Fig. 602 (Silver Code) available end connections, one wing union and two style 50 or style 10 or one Style 50 and Style 10 swivel joints with threaded ends.
- For Fig. 1502 one wing union and one each style 50 and style 10 swivel joints with integral wing union ends.
- Four wing unions and two style 50 or 10 swivel joints with integral wing union ends.
- Four wing unions and two style 50 or style 10 swivel joints.



**ADJUSTABLE CHOKE**



**POSITIVE CHOKE**

- Standard service is used up to 15000 psi and tested at 22500 psi.
- Sour service(H<sub>2</sub>S) is used up to 10000 psi and tested at 15000 psi.
- Hammer Union end connections.
- Forged alloy steel body, stainless steel, and tungsten carbide parts.
- Parts are interchangeable with major brands.
- Suitable for a broad range of operations including wellhead and well tastings.

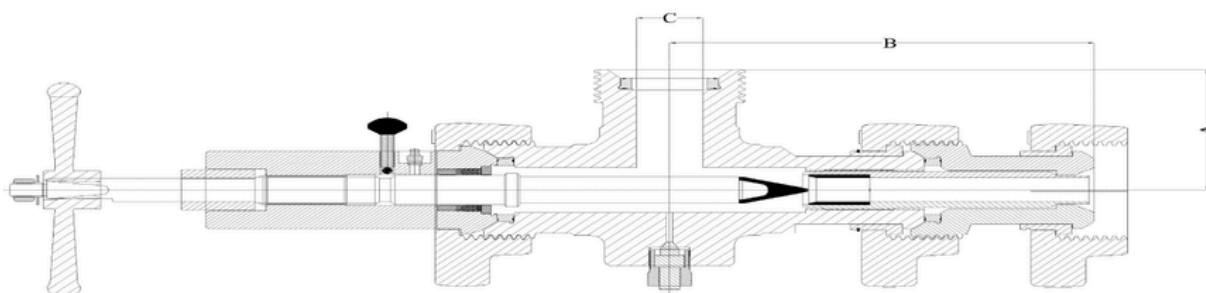

Sizes	Services	Working Pressure psi	Seat	Type	A	B	C	Wt. Lb (Kg)
2"	Std	15000	¾", ¾" full 1" full	Adjustable	5.00"	11.66"	1.88"	63.00 (29.0)
	Sour	10000						
2"	Std	15000	¾", ¾" full 1" full	Positive	5.00"	11.66"	1.88"	103.00 (46.7)
	Sour	10000						
3"	Std	15000	2" half & full	Adjustable	8.00"	8.00"	2.75"	132.30 (60.0)
	Sour	10000						

## CHOKE PART LIST

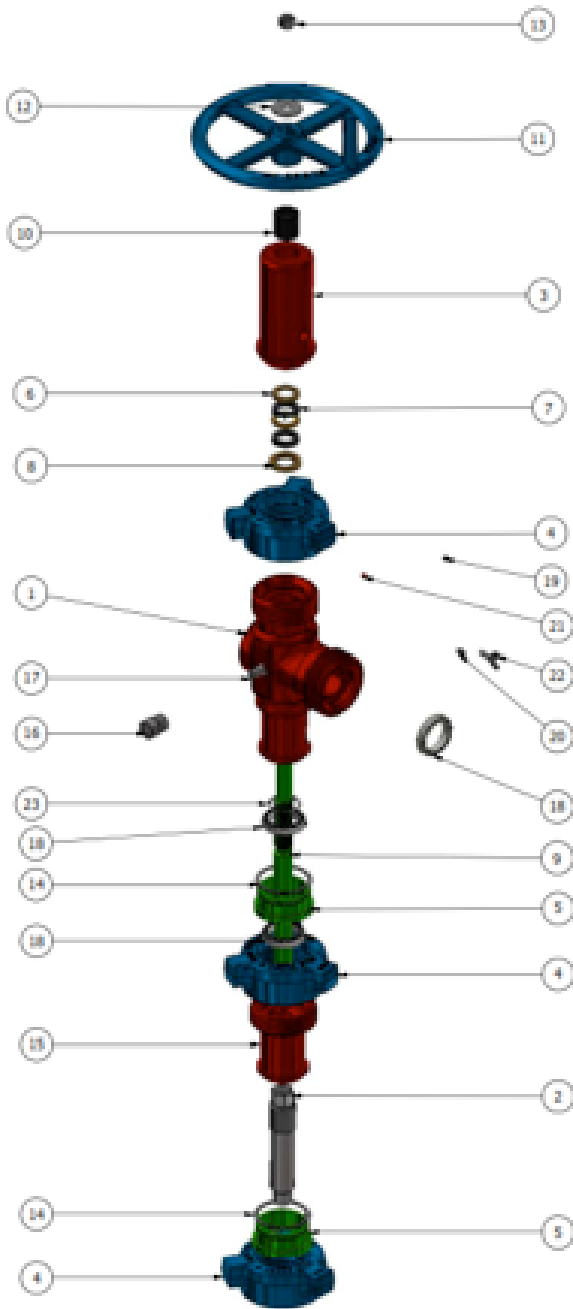

Item	Qty.	Description
1	1	Body
2*	1	Bean Body
3	1	Bonnet
4	3	Nut
5	2	Segment Ring
6*	2	Back Spacer
7*	2	Lip seal
8*	1	Front Spacer
9	1	Stem Body
10	1	Valve Indicator
11	1	Hand Wheel
12	1	Washer
13	1	Hex Nut
14	2	Retainer Ring
15	1	Saver
16	1	Pressure relief valve
17	1	Test Plug
18	3	Seal Ring
19	1	Hexagon socket screw set
20	1	Grease Nipple
21	1	Nylon Ball
22	1	Wing screw
23	1	Internal snap ring









### REPAIR KIT DETAILS

**\* Marked Items are supplied as major repair kit for Choke**



## Integral Fitting Specifications

Nom. Size in.		1	1.5	2			3			4		
Figure No.		1502	1502	602	1502	2002	602	1502	2002	602	1002	1502
CWP (PSI)		15000	15000	6000	15000	15000	6000	15000	15000	6000	10000	15000
Long sweep Elbow	F X M Wt. (Kg.)	-	-	10	12.6	-	24.5	22.9	-	40.4	40.4	-
	M X M Wt. (Kg.)	-	-	12.2	15.4	-	30	29.5	-	46.3	46.3	-
Elbows	F X M Wt. (Kg.)	-	-	12.4	14.7	-	45.6	46.3	100	-	-	-
	M x M Wt. (Kg.)	-	-	16.3	18.5	-	52.2	54.9	-	-	-	-
	F x F Wt. (Kg.)	-	-	8.2	10.9	-	38.1	39.5	-	-	-	-
Tees	F x F x F Wt. (Kg.)	13.2	15.4	12	13.2	14.5	50.8	51.7	99.8	44.9	45.8	90.7
	F x F x M Wt. (Kg.)	14.4	18	14.2	17	19	56.2	58	115	51.7	52.6	106
	F x M x F Wt. (Kg.)	14.4	18	14.2	17	19	56.2	58	115	51.7	52.6	106
	F x M x M Wt. (Kg.)	15.9	21.1	16.3	20.9	23.6	61.7	64.4	129	57.6	59	122
	M x M x F Wt. (Kg.)	15.9	21.1	16.3	20.9	23.6	61.7	64.4	129	57.6	59	122

Nom. Size in.		1	1.5	2			3			4		
Figure No.		1502	1502	602	1502	2002	602	1502	2002	602	1002	1502
CWP (PSI)		15000	15000	6000	15000	15000	6000	15000	15000	6000	10000	15000
Crosses	 F x F x F x F Wt. (Kg.)	-	31.8	26.3	26.8	-	71.2	61.7	-	65.3	65.5	-
	 F x F x M x F Wt. (Kg.)	-	35	28.1	30	-	76.2	80.7	-	71.2	71.2	-
	 F x F x M x M Wt. (Kg.)	-	37.6	30.4	33.1	-	81.6	83	-	77.1	77.1	-
	 F x M x M x F Wt. (Kg.)	-	37.6	30.4	33.1	-	81.6	83	-	77.1	77.1	-
	 F x M x M x M Wt. (Kg.)	-	40.4	32.7	36.3	-	87.1	89.4	-	83	83	-
	 M x M x M x M Wt. (Kg.)	-	142.6	35	39.5	-	92.1	95.7	-	89.4	89.4	-
Laterals	 M x F x F Wt. (Kg.)	26.3	27.9	21.5	24.3	-	-	40.1	-	53.1	78.9	141
	 F x F x F Wt. (Kg.)	25.4	-	-	-	-	-	40.9	-	-	-	-
Wyes	 M x F x F Wt. (Kg.)	-	20	12.7	12.2	12.7	-	-	-	-	-	-

- Dehu Fittings feature high-quality forged construction with integral union end connections for high strength.
- Dehu Integral fittings come with full material traceability.
- Dehu also supplies Integral fittings in customized end connections.

A Pup Joint is a short casing or tubing used for handling production tubing assemblies and for spacing out full length tubing and casing strings.

## Pup Joints Available

Pin x Box

Pin x Pin

## Available Lengths

2', 3', 4', 5', 6', 8', 10' & 12'

Standard length tolerance

## Available API Grade :

- H40
- J55
- K55
- N80
- R95
- L80
- C90
- T95
- C110
- P110
- Q125



**Integral Pup Joint**



**NPST Pup Joint**



- Dehu offers 2” & 3” 15000 PSI (Code Red) Integral alloy steel pup joints are available in lengths up to 12 feet.
- They feature an entirely one-piece, upset-forged construction, made for use where welded or threaded connections are not recommended.
- These pup joints can be used with the complete range of high-pressure and abrasive oilfield fluids.
- Available in both standard and sour service.

Wt.	lb/kg	lb/kg	lb/kg	lb/kg	lb/kg	lb/kg	lb/kg
Size	2.0”	3.0”	4.0”	5.0”	6.0”	8.0”	10.0”
<b>2” Integral</b>	34 / 15.4	42 / 19.1	50 / 22.7	60 / 27.2	71 / 32.2	80 / 36.3	98 / 44.5
<b>3” Integral</b>	69 / 31.2	91 / 41.3	113 / 51.3	136 / 61.7	158 / 71.7	191 / 86.6	237 / 107.5
<b>2” NPST</b>	31 / 14.1	38 / 17.2	45 / 20.4	52 / 23.6	59 / 26.8	72 / 32.7	86 / 39.0
<b>3” NPST</b>	57 / 25.9	72 / 32.7	87 / 39.5	103 / 46.7	118 / 53.5	148 / 67.1	178 / 80.7

- Dehu Non-pressure Seal Pup joints are available in 1”, 2” & 3” nominal sizes.
- These Pup joints are 100% hydrostatically tested at 1.5 times the rated cold working pressure.
- Standard lengths range from 1 foot up to 12 feet at cold working pressure, 10000 PSI (Sour) and 15000 PSI (Standard).
- Non-Standard lengths are available with minimum lead time.

Couplings are short subassemblies used to enable two components with the same connection and size to be connected. Couplings are also known as loose coupling and spare coupling..

**Size Range**

OD: 2 3/8” to 20”.

Thread Connection 8RD, BTC, API.

**Available API Grade :**

- H40
- J55
- K55
- N80
- R95
- L80
- C90
- T95
- C110
- P110
- Q125



Our extensive range of high-performance couplings is precision-engineered and crafted from API-grade coupling stock, meticulously sourced from trusted seamless mills. Each product is designed to meet the highest standards of reliability and durability, ensuring seamless operation in demanding applications.

<b>Tubing Couplings</b>	
Diameters	2 3/8" - 4 1/2"
Grades	J55, L80, N80, P110
Connections	NUE, EUE
Other Options	<ul style="list-style-type: none"> <li>• Special clearance</li> </ul>
	<ul style="list-style-type: none"> <li>• Bevel one end or both ends</li> </ul>
	<ul style="list-style-type: none"> <li>• Seal ring couplings (modified)</li> </ul>

<b>Casing Couplings</b>	
Diameters	4 1/2" - 20"
Grades	J55, K55, N80, L80, P110, Q125
Connections	BTC , LTC , STC
Other Options	<ul style="list-style-type: none"> <li>• Crossover couplings</li> </ul>
	<ul style="list-style-type: none"> <li>• Seal ring couplings (Modified)</li> </ul>



<b>Casing Coupling Packing Standard</b>									
SIZE (inch)	TYPE	T.L. Coupling (mm)	OD	Coupling Weight in KG.	QTY PER BOX	NT.WT/ BOX KG.	NT.WT/ BOX LBS	GR.WT/ BOX KG.	GR.WT/ BOX LBS
4 1/2	STC	158.75	133.35	5.24	343	1797	3962	1847	4072
5	STC	165.1	147.32	6.43	294	1890	4168	1940	4277
5 1/2	STC	171.45	160.02	7.34	252	1849	4078	1899	4187
7	STC	184.15	200	10.88	200	2176	4797	2226	4907
7 5/8	STC	190.5	215.9	12.16	150	1824	4021	1874	4131
8 5/8	STC	196.85	244.8	15.62	112	1749	3857	1799	3966
9 5/8	STC	196.85	269.88	17.85	112	1999	4407	2049	4517
10 3/4	STC	203.2	298.45	20.58	63	1296	2858	1346	2967
13 3/8	STC	203.2	365.12	25.42	54	1372	3026	1422	3135
16	STC	228.6	431.8	34.33	30	1029	2271	1079	2379
18 5/8	STC	288.6	508	53.33	16	853	1881	903	1991
20	STC	228.6	533.4	42.81	16	684	1510	734	1618



<b>Casing Coupling Packing Standard</b>									
SIZE (inch)	TYPE	T.L. Coupling (mm)	OD	Coupling Weight in KG.	QTY PER BOX	NT.WT/ BOX KG.	NT.WT/ BOX LBS	GR.WT/ BOX KG.	GR.WT/ BOX LBS
4 1/2	LTC	177.8	133.35	5.96	294	1752	3862	1802	3973
5	LTC	196.85	147.32	7.86	245	1926	4246	1976	4356
5 1/2	LTC	203.2	160.02	8.92	216	1927	4248	1977	4358
7	LTC	228.6	200	13.92	150	2088	4603	2138	4713
7 5/8	LTC	234.95	215.9	15.63	125	1954	4308	2004	4418
8 5/8	LTC	254	244.8	21.67	80	1734	3823	1784	3933
9 5/8	LTC	266.7	269.88	25.45	80	2036	4489	2086	4599

### Casing Coupling Packing Standard



SIZE (inch)	TYPE	T.L. COUPLING (mm)	OD	COUPLING WEIGHT in KG.	QTY PER BOX	NT.WT / BOX	NT.WT / BOX LBS	GR. WT / BOX	GR. WT / BOX LBS
7	BTC	254	200	13.98	150	2097	4623	2147	4733
7 5/8	BTC	254	215.9	15.82	125	1978	4361	2028	4471
8 5/8	BTC	269.88	244.8	20.86	80	1669	3679	1719	3790
9 5/8	BTC	269.88	269.88	23.16	80	1853	4085	1903	4195
10 3/4	BTC	269.88	298.45	25.74	54	1390	3064	1440	3175
13 3/8	BTC	269.88	365.12	31.77	54	1716	3783	1766	3893
16	BTC	269.88	431.8	40.28	30	1208	2663	1258	2773
18 5/8	BTC	269.88	508	62.68	16	1003	2211	1053	2321
20	BTC	269.88	533.4	50.1	16	802	1768	852	1878

### Tubing Coupling Packing Standard

SIZE (inch)	TYPE	T.L. COUPLING (mm)	OD	COUPLING WEIGHT in KG.	QTY PER BOX	NT.WT / BOX	NT.WT / BOX LBS	GR. WT / BOX	GR. WT / BOX LBS
2 3/8	EUE	123	77.8	1.55	1144	1773	3909	1823	4019
2 7/8	EUE	133	93.8	2.4	792	1901	4191	1951	4301
3 1/2	EUE	146	114.8	4.1	448	1837	4050	1887	4160
4 1/2	EUE	158	141.3	6.05	294	1779	3922	1829	4032
2 3/8	NUE	107	73.02	1.28	1144	1464	3228	1514	3338
2 7/8	NUE	130	88.9	2.34	800	1872	4127	1922	4237
3 1/2	NUE	142	107.95	3.71	448	1662	3664	1712	3774
4 1/2	NUE	155	132.08	4.89	343	1677	3697	1727	3807

## Pup Joint Packing Standard

SR. NO.	SIZE	Length	PALLET SIZE	QTY (Nos)	NT WT. KG.	NT WT. LBS
1	2 3/8"	2FT	700 X 700	80	504	1111
2	2 3/8"	4FT	1300 X 700	80	744	1640
3	2 3/8"	6FT	1900 X 700	64	928	2046
4	2 3/8"	8FT	2500 X 700	56	1050	2315
5	2 3/8"	10FT	3100 X 700	56	1395	3075
6	2 7/8"	2FT	700 X 700	70	606	1336
7	2 7/8"	4FT	1300 X 700	70	1050	2315
8	2 7/8"	6FT	1900 X 700	49	1026	2262
9	2 7/8"	8FT	2500 X 700	49	1152	2540
10	2 7/8"	10FT	3100 X 700	42	1234	2720
17	3 1/2"	2FT	700 X 700	60	769	1695
18	3 1/2"	4FT	1300 X 700	60	1309	2886
19	3 1/2"	6FT	1900 X 700	48	1443	3181
20	3 1/2"	8FT	2500 X 700	42	1624	3580
21	3 1/2"	10FT	3100 X 700	36	1706	3761
22	4 1/2"	2FT	700 X 700	45	492	1085
23	4 1/2"	4FT	1300 X 700	40	923	2035
24	4 1/2"	6FT	1900 X 700	35	1099	2423



**Flow Couplings**

Diameter	2 3/8" , 2 7/8" , 3 1/2"
Grade	J-55, L-80, N-80 (Q), P-110
Connections	EUE, LTC, STC, BTC
Lengths	2' , 3' , 4' , 6' , 8' , 10'

**Blast Joints**

Diameter	2 3/8" , 2 7/8" , 3 1/2" , 4 1/2"
Grade	J-55, L-80, N-80 (Q), P-110
Connections	API - EUE, P x P, B x P
Lengths	3' , 4' , 5' , 6' , 10' , 12'
Weight	Standard, and heavy walls available upon request
Product Specification Level	PSI, Ps2, Psc3
Other options	Longer than 12' upon request

**Cross Over**

Diameter	2 3/8" - 9 5/8"
Grade	J-55, L-80, N-80 (Q), P-110
Connections	EUE, LTC, BTC
Lengths	10" , 12" , 14" , 16" , 18"

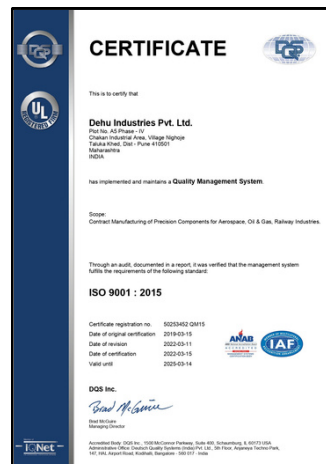

**Gat no. 37, Gatha Mandir Bypass,  
Near Bharat petroleum Gas station,  
Dehugaon, Maharashtra 412109**

